

eliwell



Compact controller for compressor plants

Summary

INTRODUCTION - Characteristics	4
CONDITIONS OF USE.....	4
MECHANICAL ASSEMBLY.....	7
WIRING DIAGRAMS.....	7
CONNECTION DIFFERENCES BETWEEN EWCM412/415/418 and EWCM4120/4150/4180	13
BASIC FUNCTIONS	14
LEDs.....	14
Displays in particular states.....	15
Keys.....	16
User interface configuration.....	17
Main display.....	19
Password and visibility.....	19
Accessing and using the menus.....	20
Machine state menu	20
Programming menu	21
CONFIGURING THE MACHINE.....	21
1) ANALOGUE INPUTS (AI3, AI4).....	21
3) HIGH/LOW VOLTAGE DIGITAL OUTPUTS (DO1...DO6)	25
4) PWM/OPEN COLLECTOR OUTPUTS AO1 AND AO2	26
5) TRIAC TC OUTPUT.....	29
6) LOW VOLTAGE ANALOGUE AO3 OUTPUT	30

COMPRESSOR CONTROL.....	31
Inverter compressor control.....	32
Digital compressor control.....	34
Compressor timing.....	36
Power stages.....	37
Compressor switch-on policies.....	37
CONDENSATION CONTROL.....	39
INVERTER COMPRESSOR CONTROL.....	40
DIGITAL FAN CONTROL.....	44
ADVANCED FUNCTIONS.....	49
On/off device.....	49
Recording operating hours.....	50
Real Time Clock (RTC).....	50
ALARMS.....	51
Alarms list with description and activation parameters.....	53
Alarm list with actions and notes.....	55
Alarms log.....	58
SERIAL CONFIGURATION.....	59
PARAMETERS LIST.....	61
NAVIGATION MENU DIAGRAMS.....	69
ACCESSORY PRODUCTS.....	72
TECHNICAL DATA.....	73
Mechanical characteristics.....	73
Electrical characteristics.....	73
Input/Output characteristics.....	73

INTRODUCTION - CHARACTERISTICS

The EWCM is a device which represents a family of controllers dedicated to managing the production room of a refrigerator plant:

- Configurable user interface.
- Configurable navigation menu.
- Alarms log.
- Temperature control via inlet probe depending on configuration and installation.
- Condensation control via outlet probe depending on configuration and installation.
- NTC, 4...20 mA, 0...5V or 0.10V parameter-configurable inputs.
- Parameter settings via keyboard or PC.
- Copy card for uploading and downloading parameter maps.
- Control of a single circuit with up to 4 compressors (or combination of compressors) whole or segmented with up to 4 power *stages*/inverter compressor.
- Condensation control with inverter fan or up to 4 digital fans.

CONDITIONS OF USE

Permitted use

This device is intended for controlling compressor plants.

For safety reasons, the instrument must be installed and used according to the instructions provided and in particular, under normal conditions, parts bearing dangerous voltages must not be accessible. The device must be adequately protected from water and dust as per the application, and must also only be accessible via the use of tools (with the exception of the frontlet).

The device is ideally suited for use in household appliances and/or similar refrigeration equipment and has been tested with regard to the aspects concerning European reference standards on safety. It is classified as follows:

- according to its manufacture: as an independently mounted or integrated automatic electronic control device to be incorporated;
- according to its automatic operating features, as a 1 B-type operated control type;
- as a Class A device in relation to the category and structure of the software;
- as a device with pollution grade 2;
- as a device with class D fire resistance;
- overvoltage category grade II
- as a device made with class IIIa material.

Uses not permitted

Any use other than that expressly permitted is prohibited.

The relay contacts supplied are of the functional type and subject to fault (since they are electronically controlled they are prone to short-circuit or remaining open): any protection devices specified in product standards or suggested by common sense for obvious safety requirements must be installed externally to the instrument.

RESIDUAL RISKS AND RESPONSIBILITIES

Eliwell is not liable for damage due to:

- unspecified installation/use and, in particular, in contravention of the safety requirements of established legislation or specified in this document;
- use on equipment which does not provide adequate protection against electrocution, water and dust in the actual installation conditions;
- use on equipment which allows toolfree access to dangerous components;
- tampering with and/or alteration of the products;
- installation/use on equipment which does not comply with established legislation and standards.

DISCLAIMER

This document is the exclusive property of ELIWELL CONTROLS Srl and shall not be reproduced or distributed without authorisation of ELIWELL CONTROLS Srl.

Although great care has been exercised of this document, ELIWELL CONTROLS Srl, its employees or its vendors, cannot accept any liability whatsoever connected with its use.

The same applies to any person or company involved in preparing and editing this document.

ELIWELL CONTROLS Srl reserves the right to make any changes or improvement without prior notice.

ELECTRICAL WIRING

Attention! Never work on electrical connections when the machine is switched on. The operation must be carried out by qualified personnel.

To ensure proper connections, comply with the following:

- using a power supply which does not correspond to the specifications given, can seriously damage the system;
- use cables of suitable section for the terminals used.
- Separate, as much as possible, the cables of probes and digital inputs from inductive loads and power connections to prevent electromagnetic interference. Do not place the probe cables near other electrical equipment (switches, meters, etc.)
- Make connections as short as possible and do not wind them around electrically connected parts. It is recommended to use screened wires for probe connections.
- To avoid causing static discharges, do not touch the electronic components on the boards.

Eliwell supplies the high voltage cables to connect the device to loads, the power supply, probes, digital inputs, etc. according to p/n - see the Accessories chapter.

The device must be connected to a suitable transformer that complies with the specifications provided in the Technical Data chapter.

MECHANICAL ASSEMBLY

The instrument is designed for panel mounting. Make a 29x71 mm hole and insert the instrument; secure it with the special brackets provided. Do not mount the instrument in damp and/or dirt-laden areas; it is suitable for use in places with ordinary or normal levels of pollution. Keep the area around the instrument cooling slots adequately ventilated. The TTL serial port is located on the left side of the instrument.

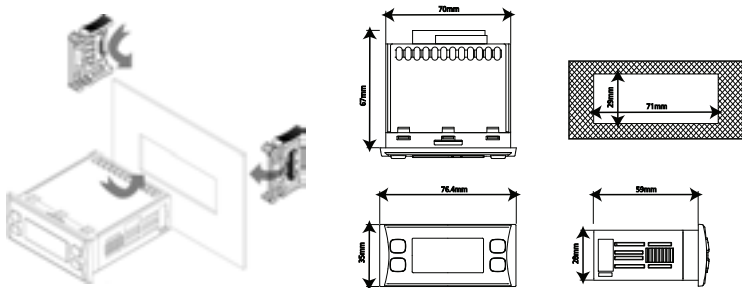

WIRING DIAGRAMS

Circuit diagram key

12V~	12V~ power supply
5V=	5V= power supply for 10A max ratiometric transducer
12V=	Auxiliary 12V= power supply for AO1 or DO5 output

DO1... DO6	2A - 230V~ high voltage relay outputs	
N	Neutral	
TC	TRIAC 2A - 230V~ high voltage output	
AO1/AO2	PWM/Open collector analogue output for external fan module (to be used with 12V~)	
AO3	0/10 V, 4-20 mA, 0-20 mA low voltage analogue output	
DO5	Open collector output (to be used with 12V~)	
DI1...DI5	Digital inputs voltage-free contact (closing current to 0.5mA ground)	
AI1 (DI6)..AI2 (DI7)	Digital inputs voltage-free contact (closing current to 0.5mA ground)	
AI3..AI4	NTC */ voltage, current** / Digital Input configurable analogue inputs***	
GND	Ground	
TTL (COM 1)	TTL serial for connection to Copy Card/ ParamManager/ DeviceManager or Televis	
INPUT	1	Outlet pressure switch ON/OFF (EWCM 4120 and EWCM 4180)
	2	Inlet pressure switch ON/OFF
	3 ... 6	Block compressor 1... 4 ON/OFF
	7	Remote ON/OFF
	8	Outlet probe (EWCM 4180)
	9	Inlet probe
OUTPUT	10 ... 13	Compressor/power step 1_4 ON/OFF
	14	TC high voltage condenser fan (EWCM 4120)
	15	TC low voltage condenser fan (EWCM 4180)
	16	Low voltage ON/OFF alarm (EWCM 4120)
	17	ON/OFF alarm (EWCM 4150 and EWCM 4180)

* SEMITEC 103AT type (10LΩ / 25°C).

** 4...20mA current input or 0...5V/0...10V voltage input or voltage-free digital input.

*** voltage-free digital input.

EWCM 4120

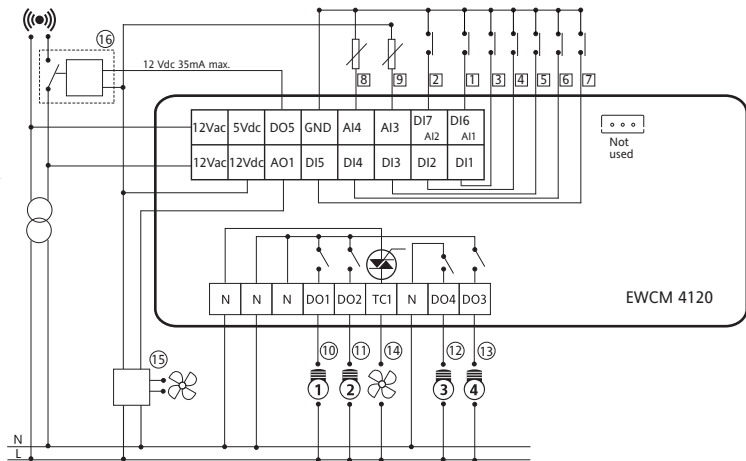

EWCM 4150

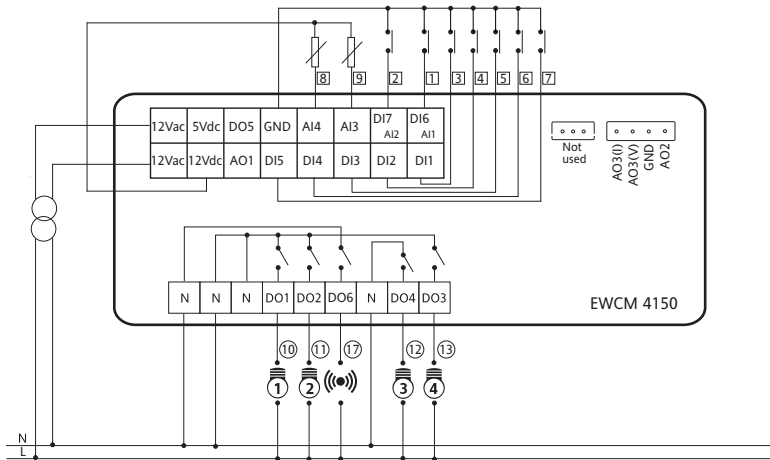

EWCM 4180

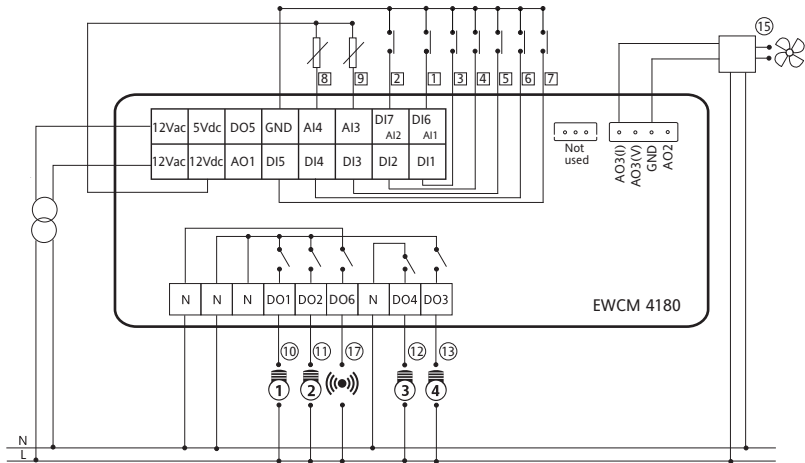

Examples of probe connections

● NTC

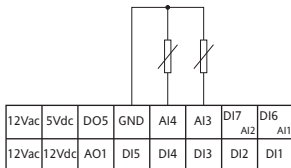

● EWPA 4/20mA

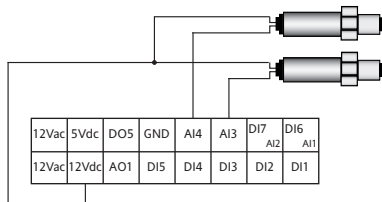

● EWPA R 0/5V

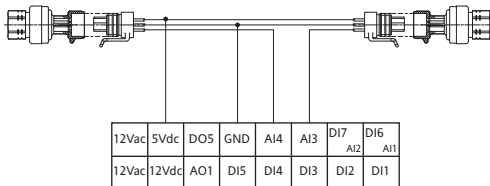

CONNECTION DIFFERENCES BETWEEN EWCM412/415/418 and EWCM4120/4150/4180

The main differences between EWCM412/415/418 and EWCM4120/4150/4180 are listed below:

- The terminals of connectors EWCM412/415/418 are different from those of EWCM4120/4150/4180.
- The alarm output on EWCM412 (12-24V~ max 500mA output for use with 12V~ insulated from power supply of device) is replaced with an open collector output (with parameter configurable function) for use with 12V~. **PLEASE NOTE:** the terminals of the connector, to be used for this output, do not correspond between EWCM412 and EWCM4120 (see diagram below).
- The relays of EWCM4120/4150/4180 do not have a single common contact as on EWCM412/415/418; output DO4 is separate from the other outputs (DO1, DO2 and DO3)

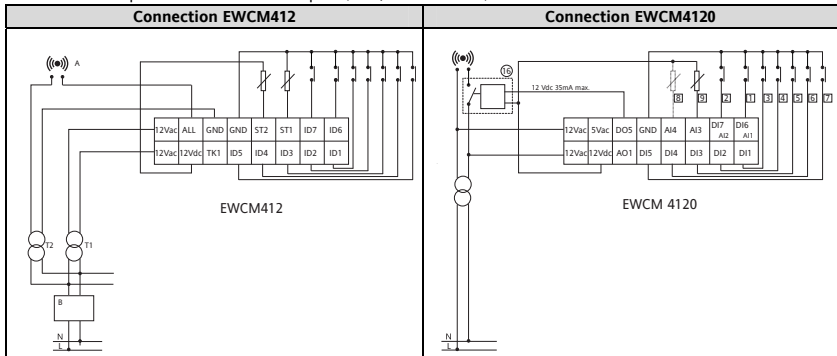

BASIC FUNCTIONS

The user has a display and 4 keys for programming the instrument and checking its status.

When the instrument is powered on for the first time it performs a lamp test, during which time the display and LEDs flash for several seconds to check that they all function correctly. The instrument has two main menus, the "Machine state" menu and the "Programming" menu.















EWCM4120 and EWCM4180



EWCM4150

LEDs





Symbol / icon	Description	Icon on front panel
 (8) ... (11)	EWCM4120-EWCM4180 Fan bar (configurable LEDs using parameters UI07...UI10) EWCM4150 LEDs NOT configured (configurable LEDs using parameters UI07...UI10)	 
	Programming menu	
	Alarm. If permanently on the alarm is active, if flashing the alarm is silenced.	
	Heating. Heating mode	

	Cooling. Cooling mode	
	Display of temperature values in °C/°F	
Bar	Display of pressure values in Bar	
Psi	Display of pressure values in Psi	
 (1) ... (4)	Compressor ON (LED configurable using parameters UI00...UI03)	
 (5) ... (7)	LEDs NOT configured (Led configurable using parameters UI04...UI06)	

Displays in particular states

Status	Display	LEDs /icons
If there is an alarm	Main display alternated with alarm code (if more than one alarm is present simultaneously, the one with the lower index will be displayed)	Alarm icon permanently on If alarm is silenced it will flash
	If the measurement on the main display is incorrect, the error code will be displayed; If a further alarm is present, it will alternate between "----" and the error code.	
Remote ON/OFF	Display " OFF " flashing	All off
ON/OFF keyboard/local	Display " OFF " continuous	All off

Keys

	<p>SET key used to:</p> <ul style="list-style-type: none">• SET function: access “machine state” menu.• access menu subfolders.• access parameter value.• Confirm parameter value and/or exit.• prg (Programming menu): press and hold (5 secs) to access the Parameters folders from the main display.
	<p>UP key used to:</p> <ul style="list-style-type: none">• Scroll down the displayed folders and parameters.• Increase parameter value (if in parameter edit mode).• Band: press and hold (5 sec.) to enter the menu for viewing/editing the compressor plant adjustment range.
	<p>DOWN key used to:</p> <ul style="list-style-type: none">• Scroll up the folders and parameters display.• Decrease the parameter value (if in parameter edit mode).• set: Press and hold (5 secs) to access the menu for viewing/editing the setpoint adjustment, and the type of set point will be displayed. To edit the set point, use the “set” key to display the value and the “Up” and “Down” keys to edit it. Press “set” to confirm or “func” to exit (see Note).
	<p>FNC key used to:</p> <ul style="list-style-type: none">• Menu exit, parameter list, parameter value (without saving value) and return to the previous level.• disp: by holding down for some time (5 secs) access is provided to the menu for selecting the main display. Using the “up” e “down” keys, only the values that have been configured as present in the device will be displayed (flashing) and the selection is confirmed by pressing the “set” key.



If any alarms are present, they can be reset by simultaneously pressing the **UP + DOWN** keys.

Press any key to silence the alarms; If there is an alarm, pressing a key once will silence it and will not activate the corresponding function.

User interface configuration

The LEDs are configured using parameters **UI00..UI10**:

LED utilities table:

Value	Description	ON	Flashing
0	LED disabled	-	-
1 _ 4	Compressor 1... 4	Active	Interstep timing
5	Step 2 compressor 1	Active	Interstep timing
6	Step 2 compressor 2	Active	Interstep timing
7	Step 2 compressor 3	Active	Interstep timing
8	Step 3 compressor 1	Active	Interstep timing
9	Step 3 compressor 2	Active	Interstep timing
10	Step 4 compressor 1	Active	Interstep timing
11 ...14	Fan 1 ... 4 ON	Active	Interstep timing
15	Alarm	Active	Silenced
16 ... 22	Not used	-	-
23	Compressor inverter enabling	Active	-
24	Fan inverter enabling	Active	-
25	Inverter fan	Active	Interstep timing

26	Inverter compressors	Active	Interstep timing
27	Inverter fan bar $\geq 25\%$	Active	-
28	Inverter fan bar $\geq 50\%$	Active	-
29	Inverter fan bar $\geq 75\%$	Active	-
30	Inverter compressor bar $\geq 25\%$	Active	-
31	Inverter compressor bar $\geq 50\%$	Active	-
32	Inverter compressor bar $\geq 75\%$	Active	-

User interface configuration parameters:

Par.	Description	Min	Max	U.M.	Notes
UI12	Select main set point display	0	1	num	0=display Inlet Set 1= display Outlet Set
UI13	Select main display	0	6	num	
UI20	Installation password	0	255	num	Default UI20= 1
UI21	Manufacturer password	0	255	num	Default UI21=2
UI22	Unit of temperature measurement	0	1	num	0= $^{\circ}\text{C}$, 1= $^{\circ}\text{F}$
UI23	Unit of pressure measurement	0	1	num	0=Bar, 1=Psi

Parameters UI20 - UI21

In parameters UI20 and UI21 respectively, the installer (level 1) password and manufacturer (level 2) password must be changed. See PASSWORD AND VISIBILITY chapter.

Main display

Under normal operating conditions, it is possible to select which measurement to display on-screen (not in the navigation menu or in the case of alarms).

Press and hold the “FNC” key to access the folder containing all of the available measurements. The only measurements which will be displayed, flashing on-screen, are those which can be selected and which are present in the device (for example The RTC will appear in the list only if it has been configured as present). The list is as follows:

- AI01...AI04 (one of the probes available among those configured in the device)
- RTC (clock)
- Set point; In OFF, the set point displayed is the set point for the previous operating mode in OFF status.

The following procedure describes how to set the main display:

- Press the “FNC” key for 5 seconds (value configurable from parameter UI19)
- select the measurement to display by scrolling through the various options using the Up and Down keys
- press the “set” key

Par.	Description	Min	Max	U.M.	Notes
UI13	Main display	0	6	num	0=analogue input 1, 1=analogue input 2, 2=analogue input 3, 3=analogue input 4, 4= analogue input 5, 5= clock, 6= set point configured

NOTE: Either the inlet setpoint or the outlet setpoint will be displayed, depending on parameter **UI12** (select main set point display).

Password and visibility

To view parameters visible for the given password, open folder **PASS** (in the Parameters menu **PAR**) and set the level1 value (set in parameter **UI20**) or level2 value (set in parameter **UI21**). The visibility of the parameters and the folders during menu navigation can be configured by assigning appropriate values to each parameter and folder. This operation can only be performed using suitable software (**Parammanager** or other communication SW).

The visibility levels are:

- Value **0** = Parameter or folder **not visible**.
- Value **1** = installer level; These parameters can only be viewed by entering the Password 1 value (all parameters specified as always visible and parameters that are visible at the installation level will be visible).
- Value **2** = manufacturer level; These parameters can only be viewed by entering the Password 2 value (all parameters specified as always visible, parameters that are visible at the installation level, and manufacturer level parameters will be visible).
- Value **3** = parameter or folder **always visible**.

Accessing and using the menus

Resources are organised into menus and viewed by briefly tapping the “set” key (“Machine state” menu) or by keeping the “set” key pressed for more than 5 seconds (“Programming” menu). Press the “set” key once to view the contents of any folder highlighted by the corresponding label. At this point it is possible to scroll through the contents of any folder, editing it or using the functions envisaged for it. Either do not press any keys for 15 seconds (time-out) or press the “fnc” key once, to cancel the parameter modifications and return to the previous screen. **WARNING:**Not all of the parameters are visible if the 1 or 2 level password has not been previously entered.

Machine state menu

From the states menu you can view values for each resource.

Some of the resources have “dynamic” visibility, e.g. if there are no alarms present then the AL folder will not be displayed.

Folder	Resources						Visibility	Description	Edit
AI	AI01	AI02	AI03	AI04			Dynamic	Analogue inputs	//
di	di01	di02	di03	di04	di05	//	Dynamic	Digital Input	//
AO	tC1	AO1	AO2	AO3	//	//	Dynamic	Analogue outputs	//
dO	dO01	dO02	dO03	dO04	dO05	dO06	Dynamic	Digital outputs	//
CL	HOUr	dAtE	YEAr					Clock	YES

AL	Er00	Er99	Dynamic	Alarms	//
SP	(1)*	//	//	//	//	//		set point(set)	YES
Hr	CP01	...	CP04	Fn01	...	Fn04	Dynamic	Operating hours Compressors / fans	YES
SC	CP01	...	CP04					Compressor selection	//

As you will be able to see from the table, the setpoint SP and time can be modified and viewed.

(1) * The following type is initially indicated for the set point: **SUCTION** Set, **DISCHARGE** Set. Press the "set" key once again to view/edit the set point value.

Programming menu

Menu	Folder	Subfolders										Description
Parameters	PAr	CF	Ui	St	CP	Fn	AL	Pass	CC	OP		Parameters
EU	EU	Eu00	Eu99	Alarms log
EUR	EUR											Reset alarm history

CONFIGURING THE MACHINE

1) ANALOGUE INPUTS (AI3, AI4)

The device has 2 analogue inputs which are configurable using the following parameters:

CF02*	Type of analogue AI3 input	CF07	Analogue AI4 input start of scale value
CF03*	Type of analogue AI4 input	CF10	Analogue AI3 input differential
CF04	Analogue AI3 input end of scale value	CF11	Analogue AI4 input differential
CF05	Analogue AI3 input start of scale value	CF14**	Configuration of analogue AI3 input
CF06	Analogue AI4 input end of scale value	CF15**	Configuration of analogue AI4 input

See Parameters F04 ... CF11 limits table

* If inputs AI3 and AI4 **are not** set as DI, parameters CF25 and CF26 parameters must be set to 0. Failure to observe this rule may result in malfunctions.

** If inputs AI3 and AI4 **are** set as DI, parameters CF14 and CF15 parameters must be set to 0.

*** The unit of measurement (U.M.) is selected based on parameters CF02 and CF03 and parameters UI22 (C°/F°) and UI23 (Bar/Psi).

Inputs **AI3** and **AI4** are configurable as indicated in the following table (**CF02 ... CF03**):

Value	Type	Description
0	None	Probe not configured
1	DI	Probe configured as potential-free contact digital input
2	NTC	NTC probe range -50.0°C ÷ 99.9 °C
3	4-20mA	Analogue input 4-20 mA
4	0-10V	Analogue input 0-10 V
5	0-5V	Analogue input 0-5 V

Notes:

If an input is configured as NTC, the corresponding parameters are always displayed with the “thermometer” icon. (UI22=0/1; U.M.= C°/F°)

If an input is configured as 4-20mA, 0-10V or 0-5V, the corresponding parameters are displayed with U.M. =Bar if UI23=0 with U.M.=Psi if UI23=1.

Parameters CF04 ÷ CF07

Indicate the reading scale analogue limit values for inputs configured as 4-20mA, 0-10V, 0-5V. (Inputs 3 and 4 only)

If the input is not configured as input 4-20mA, 0-10V, 0-5V, the end of scale parameters lose meaning.

Parameters CF10 ÷ CF11

Indicate the correction values to add to or subtract from the analogue inputs; by means of this parameter it is possible to calibrate the temperature/pressure value read by the device. The value given by the instrument reading \pm "Alxx analogue input differential" will be used by the regulator connected to that probe and will be displayed on-screen. **If the input is configured as a digital input, the corresponding correction parameter must be set to 0 (otherwise the digital input will not function correctly).**

Parameters CF14 ÷ CF15

Indicate the logical meaning of the analogue inputs. If the input is configured as a digital input, refer to parameters CF23..CF26.

Value	Description
0	Probe disabled
1	Inlet regulation probe *
2	Outlet regulation probe **
3	Not Used

* If CF02=4-20mA, 0-10V, 0-5V then CF14 cannot be set to 2 or 3.

** If CF03=4-20mA, 0-10V, 0-5V then CF15 cannot be set to 1.

2) DIGITAL INPUTS (DI1, DI2, DI3 DI4 and DI5)

The EWCM32x74 device has 5 digital inputs for potential-free contacts which are configurable by means of user parameters. If necessary the analogue inputs may also be configured as digital inputs.

Parameter	Description
CF16...CF20	DI1 ...DI5 digital input configuration
CF23 ...CF26*	AI ...AI4 analogue input configuration if configured as digital input

* Set = 0 if AI1 is NOT configured as DI.

Parameters CF16 ÷ CF20 and CF23 ÷ CF26

Indicate the logical meaning of the analogue inputs.

Value	Description
± 0	Input disabled
± 1	Outlet pressure switch
± 2	Inlet pressure switch
± 3...± 6	Block compressor 1...4
± 7	Continuous compressor shut-down (inverter)
± 8...± 11	Fan 1..4 thermal switch
± 12	Continuous fan/shared fans thermal switch
± 13	Remote On/Off
± 14	General alarm
± 15 ... ± 21	Not used

Polarity is defined below:

Value	Type	Description
+	Positive	Active when contact closed
-	Negative	Active when contact open

If multiple inputs are configured with the same value, only the input with the highest index is active (an OR logic is not executed)

3) HIGH/LOW VOLTAGE DIGITAL OUTPUTS (DO1...DO6)

The device has 5 or 6 digital outputs (depending on model), which are configurable by means of user parameters. The digital outputs are available as relay contacts (DO01...DO04 and DO06) or open collector low voltage outputs (DO05). If necessary, the analogue outputs (Triac and PWM, AO1, AO2 and AO3) may also be configured as digital outputs. See the following paragraph for the characteristics.

Parameter	Description
CF45... CF49	DO1... ..DO5 digital output configurations
CF50*	Configuration of digital output DO6

* Parameter present in models with 5 relays (Triac not present in these models).

The relay output and open collector can be configured as shown in the table below:

Value	Description
± 0	Output disabled
± 1...± 4	Compressor 1..4 switched on
± 5	Capacity step 1 compressor 1 relay
± 6	Capacity step 1 compressor 2 relay
± 7	Capacity step 1 compressor 3 relay
± 8	Capacity step 2 compressor 1 relay
± 9	Capacity step 2 compressor 2 relay
± 10	Capacity step 3 compressor 1 relay
± 11...± 14	Fan state 1..4
± 15	Alarm status
± 16...± 22	Not used
± 23	Compressor inverter enabling
± 24	Fan inverter enabling

Polarity is defined below:

Value	Type	Description
+	Positive	Active when contact closed
-	Negative	Active when contact open

If multiple outputs are configured to run the same resource, the outputs will be activated in parallel.

4) PWM/OPEN COLLECTOR OUTPUTS AO1 AND AO2

The device has two outputs, configurable as PWM or open collector, which pilot the fans/continuous compressors (via the CFS modules), if configured as PWM, or another resource via external relay if configured as open collector (On/Off).

The AO1 output is always present whilst the AO2 output is present on models 4150 and 4180 only.

Parameter	Description	M.U.	Min	Max
CF34	Enable analogue output AO1	num	0	1
CF35	Enable analogue output AO2	num	0	1
CF37	Analogue AO1 output phase shift	num	0	90
CF38	Analogue AO2 output phase shift	num	0	90
CF40	Analogue AO1 output pulse length (1 unit=69.4 μ s)	num	5	40
CF41	Analogue AO2 output pulse length (1 unit=69.4 μ s)	num	5	40
CF43	Analogue AO1 output configuration	num	-24*	26*
CF44	Analogue AO2 output configuration	num	-24*	26*
CF51**	Configuration of digital AO1 output	num	-24*	24*
CF52**	Configuration of digital AO2 output	num	-24*	24*

* Values from 16 to 22 are not used.

** Parameters CF51 and CF52 represent the logic assignment of outputs AO01 and AO02 if configured as digital outputs.

Note: Parameters CF37..CF41 have meaning only if the outputs have been configured as Triac outputs; The value to enter represents the phase shift between voltage and current of the motor connected to the output (obtained from $\cos\varphi$ indicated in the motor specifications).

The parameters for output AO2 are available only in models with this output.

Parameter CF34 ÷ CF35

Allow the Triac analogue output to be characterised in the following manner:

Value	Description
0	Output configured as digital
1	Output configured as Triac (for pulse piloting)

Parameters CF37 ÷ CF38

Indicate the phase shift values of the pulse output (for adaptation to inductive load) and are active if CF34=1 and CF35=1.

Parameters CF40 ÷ CF41

Indicate the duration of the pulse output (1 unit=69.4 μ s) and are active if CF34=1 and CF35=1.

Parameters CF43 ÷ CF44

Indicate the logical meaning of the Triac analogue outputs and are active if CF34=1 and CF35=1.

It is possible to pilot loads with output modulation (value 25-26) or loads with on/off type switching using the Triac as a switch.

Value	Description	Type
0	Output disabled	On/Off
1 _ 4	Compressor 1..4 switched on	On/Off
5	Capacity step 1 compressor 1 relay	On/Off
6	Capacity step 2 compressor 1 relay	On/Off
7	Capacity step 3 compressor 1 relay	On/Off
8	Capacity step 1 compressor 2 relay	On/Off
9	Capacity step 2 compressor 2 relay	On/Off
10	Capacity step 3 compressor 1 relay	On/Off
11 ... 14	Fan status 1..4	On/Off
15	Alarm status	On/Off
16 ... 22	Not used	-
23	Compressor inverter enabling	On/Off
24	Fan inverter enabling	On/Off
25	Inverter fan status	Proportional
26	Inverter compressor status	Proportional

Parameters CF51÷ CF52

Indicate the logical meaning of outputs AO01 and AO02 configured as digital outputs and are active if CF34=0 and CF35=0. For meaning see table entitled configuration of relay and open collector in high/low voltage digital outputs (DO1 ... DO6).

5) TRIAC TC OUTPUT

In certain models, the device has a high voltage Triac output which is typically used for piloting the fans/continuous compressors.

The output can be configured for proportional operation (constant speed variation) or as ON/OFF; If configured as a proportional output, the phase parameters and the pulse length of the Triac must be properly configured for better adaptation to the load characteristics.

Parameter	Description	M.U.	Min	Max
CF33	Enable analogue TC output	num	0	1
CF36	Analogue TC output phase shift	num	0	90
CF39	Analogue TC output pulse length (1 unit=69.4 μ s)	num	5	40
CF42	Analogue TC output configuration	num	-24	26

Note: Parameters CF36 and CF39 have a meaning only if the outputs have been configured as Triac outputs.

Parameter CF33

Allows the Triac analogue output to be characterised in the following manner:

Value	Type	Description
0	None	Output disabled
1	Triac	Output configured as Triac

Parameter CF36

Indicate phase shift values to pilot Triac with phase cutting in the event of inductive loads; the value to enter represents the phase shift angle between voltage and current of the motor connected to the output (obtained from the $\cos\phi$ indicated in the motor specifications).

Parameter CF39

Indicate pulse length to pilot Triac (1 unit = 69.4 μ s).

Parameter CF42

Indicate the logical meaning of Triac analogue outputs. It is possible to pilot loads with output modulation (value 25-26) or loads with on/off type switching using the Triac as a switch. For meaning see table entitled Configuration of Parameters CF43 ÷ CF44 in PWM/OPEN COLLECTOR OUTPUTS AO1 and AO2.

6) LOW VOLTAGE ANALOGUE AO3 OUTPUT

In certain models, the device has 1 low voltage analogue output configurable by means of the user parameters. Depending on the application, the output may be available as 0-10V or 4-20mA

AO3 configuration

Parameter	Description	M.U.	Min	Max
CF27	Type of output analogue AO3	num	0	2
CF30	Configuration of analogue output AO3	num	-24	26

Parameter CF27

Allows the Triac analogue output AO3 to be characterised in the following manner:

Value	Type	Description	Notes
0	0-10V	Analogue output - voltage	Modulated piloting or on/off
1	4-20mA	Analogue output - current	Modulated piloting or on/off
2	0-20mA	Analogue output - current	Modulated piloting or on/off

Parameter CF30

Indicates the logical meaning of the analogue output. It is possible to pilot loads with output modulation (value 25-26) or loads with on/off type switching using the output as switch 0-10V. For meaning see table entitled Configuration of Parameters CF43 ÷ CF44 in PWM/OPEN COLLECTOR OUTPUTS AO1 AND AO2.

COMPRESSOR CONTROL

The device can be configured to manage an inverter compressor or one or more homogenous digital compressors (max. 4) by setting parameter CP22:

Parameter	Description	Min	Max	Notes
CP22	Number of compressor steps per circuit	0	4	0=inverter compressor. ≠0=CP22 represents the number of digital compressors.

With digital compressors it is also possible to define the number of power stages by setting parameters CP23, CP24 and CP25:

Parameter	Description	Min	Max	Notes
CP23	Number of compressor steps 1	1	4	1=whole compressor ≠1= CP23 - 1 is the number of Power stages.
CP24	Number of compressor steps 2	1	3	1= whole compressor ≠1= CP24 - 1 is the capacity step
CP25	Number of compressor steps 3	1	2	1= whole compressor 2= the number of Power stages is 1

Regulation is proportional or Neutral Zone (ZN) as a function of the inlet probe (temperature or pressure control). In the case of pressure regulation, probe AI3 must be used (high resolution probe).

In local or remote OFF the compressors are switched off.

The compressors and/or relative Power stages can be directly connected to the controller via the Triac output or relay or indirectly connected via an external module (connected to controller via an PWM or analogue output):

- Direct Triac TC output.
- Indirect "PWM" output AO1, AO2 (needs external module for piloting the inverter compressor).
- Indirect 4..20mA / 0..20mA / 0..10Vcc output AO3 (needs external module for piloting inverter compressor).
- Relay output for piloting digital compressors (whole or segmented).
- Digital Output DO5 (Open Collector) using an external relay.

One or more digital inputs can be configured as compressor block inputs:

- Digital inputs DI1...DI7.
- Analogue inputs AI3 ...AI4 if configured as digital inputs.

It is also possible to configure a relay as compressor INVERTER enabling output.

Inverter compressor control

The operating mode depends on parameter **ST02**. Cold mode St02=1. Hot mode St02=0.

The inverter compressor control is proportional as a function of the inlet probe value. The following diagram indicates the compressor speed as a function of the regulation probe in the case of regulation with lateral set point (St01=1). In the case of central set point (St01=0), the proportional band is centred in the set point:

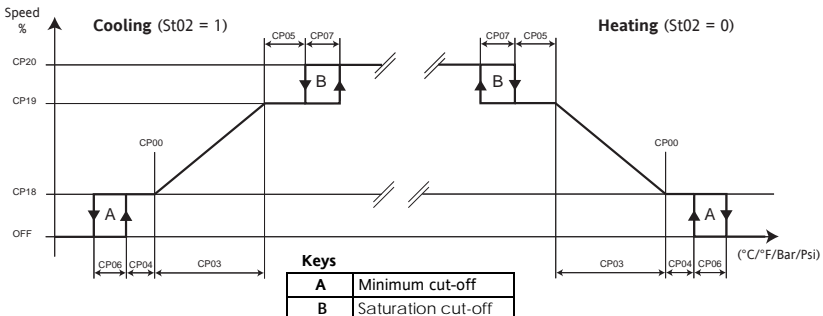

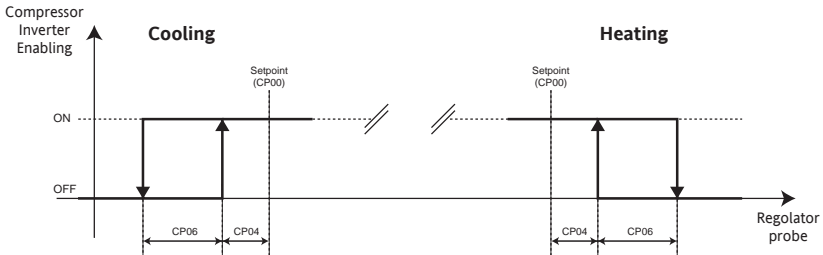

The digital inverter enabling output is activated in each case in which the analogue output has a value other than 0%. The above drawing represents only the nominal case in which the cut-off hysteresis is enabled at the minimum.

Parameters CP08 (enable minimum cut-off) and CP09 (enable saturation cut-off) activate or deactivate the cut-off function. Note that, if the minimum cut-off is disabled, the speed of the inverter compressor goes from 0 to the minimum speed when the regulation probe reaches the set point from "below". If the regulation probe reaches the set point from "above", the speed will go from minimum speed to 0. Similarly if the saturation cut-off is disabled, the speed of the inverter compressor goes from continuous regulation to maximum speed when the regulation probe reaches Set point+Proportional Band from "below". If the regulation probe reaches Setpoint+Proportional Band from "above" there will be continuous regulation between maximum and minimum speed.

Regulation probe error: the inverter compressor will be piloted at the speed set by parameter CP21.

Digital compressor control

The regulator calculates the number of refrigeration resources required by the system through a policy of assigning resources selectable with parameter **CP10** (Activation policy).

Activating or deactivating power steps must respect the activation and release times for resources CP15 and CP16 which are loaded on activation/release.

In alarm conditions, (e.g. due to the intervention of a compressor block) any reduction in power required is calculated immediately. However, the power make-up must always keep to the time intervals described above, particularly the activation time of the CP15 resources.

Proportional band: this occurs if bit0 of parameter **ST04** equals 0 (this occurs for St04=0 and St04=2).

The operation depends on the parameter **ST02**: Cooling mode if St02=1 and Heating mode if St02=0.

The digital compressor control is stepped as a function of the inlet probe value.

The regulator activates a certain number of resources (power steps) to reach the Set point configured. The number of resources required is linked to the difference between the value measured by the inlet probe and the set point; Naturally, the greater this difference, the greater the number of resources required to reach the setpoint. The temperature /pressure interval between activation of one power step and the next depends on the proportional band and the number of resources present.

In the event of a regulation probe error, the number of active power steps is calculated as a percentage set at parameter CP21 of the complete number of steps.

The following is an example of regulation with lateral set point (St01=1). In the case of central set point (St01=0) the proportional band is deemed to be centred in the set point.

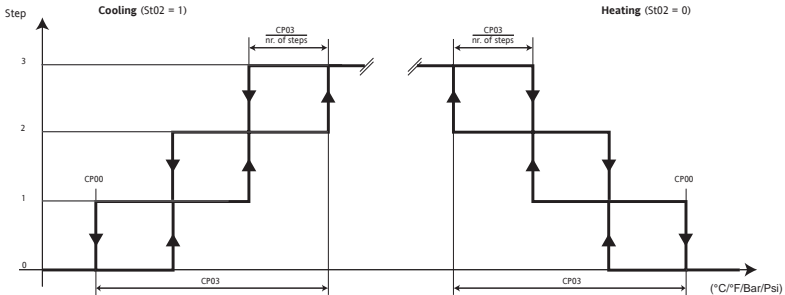

Neutral zone: this occurs if bit0 of parameter **ST04** equals 1 (this occurs for St04=1 and St04=3).

The operation depends on the parameter **ST02**: Cooling mode if St02=1 and Heating mode if St02=0.

The main function of the regulator consists in activating/deactivating a number of resources (discrete power steps) linked to the time in which the intake probe takes on values outside of the symmetric proportional band in comparison to the set point value.

For the cooling mode, for example, when the value read by the intake probe exceeds the $\text{SET POINT} + (\text{BANDA})/2$ threshold value, if the increasing interstep time (set with CP15) has already expired, an increase in power is implemented and the CP15 time is recounted (increasing interstep time). If the value read by the intake probe remains in this range, an additional power increase is activated for each "increasing interstep time" (set with CP15). The operation is similar for switching off, with the times set by parameter CP16 (decreasing interstep time).

No variation in power is required within the PROPORTIONAL BAND. Hysteresis is not included in this algorithm. All interstep times are resynchronised upon the activation/deactivation of a new compressor combination.

In the case of a regulation probe error, the number of active steps is calculated as a percentage set for the CP21 parameter of the total number of steps.

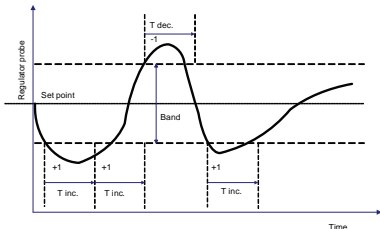
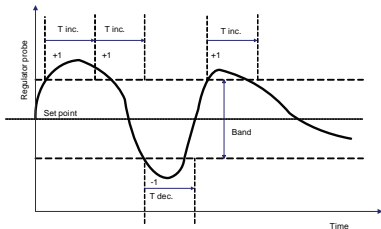

Compressor timing

The switching on and off of a compressor (inverter or digital) must meet the following requirements:

- Minimum time between switching off/on (parameter CP12). This is the minimum delay between switching off and switching on;
- Minimum time between switching off/on (parameter CP14). This is the minimum delay between switching on and switching off;
- Minimum time between switching off/on (parameter CP13). This is the minimum delay between switching on and switching on again;

The activation and deactivation of power steps for digital compressors must respect the activation and release times for resources (parameters CP15 and CP16).

Power stages

For a segmented compressor in which the number of steps corresponds to the number of segments plus one, the segmentation actuation mode depends on parameter CP11.

Parameter	Description	Min	Max	M.U.
CP11	Enable/disable sequence of relays associated to compressor power stages in the suction section	0	2	Num

For a whole compressor there are no power stages, so the compressor supplies either 0% or 100% of its power.

Example of compressor with 3 power stages (4 regulation power steps)

The compressors can supply 0%, 25%, 50%, 75% or 100% of their power.

Power	ACC	CP11=0			CP11=1			CP11=2		
		STG 1	STG 2	STG 3	STG 1	STG 2	STG 3	STG 1	STG 2	STG 3
100%	ON							ON	ON	ON
75%	ON			ON			ON	ON	ON	
50%	ON		ON	ON		ON		ON		
25%	ON	ON	ON	ON	ON					
0%										

Compressor switch-on policies

The selection policy that the inlet regulator applies in the distribution of the refrigerator resources is defined by parameter CP10. The policies available are saturation, balancing and fixed sequence.

Parameter	Description	Min	Max	M./U.	Notes
CP10	Activation Policy	0	2	Num	0= fixed sequence 1= balancing 2= saturation

The selection policies are based mainly on the hours of operation of the compressors.

They come into play when the regulator requests the activation/deactivation of a step. This request is then distributed to the most suitable compressor according to the compressor selection policy selected using CP10.

Compressor saturation: The saturation policy distributes all resources equally over the smallest number of compressors possible, so far as this is compatible with other requirements, such as: compressor safety timings. The resulting allocation is intended to have the largest possible number of compressors switched off at any one time.

Compressor balancing: The balancing policy distributes all resources equally over the largest number of compressors possible, so far as this is compatible with other requirements, such as compressor safety timings: The resulting allocation is intended to have the greatest possible equalization of power output levels in the compressors at any one time.

Fixed sequence compressors: The fixed sequence policy distributes all resources starting from the compressors with the lowest index, so far as this is compatible with other requirements, such as compressor safety timings. The resulting allocation is such as to obtain, at any given time, a maximum delivery of the compressors with lower indexes.

Hours of use of compressors

The operating time of the compressors is stored every hour in EEPROM for the purpose of:

- Managing the compressor switch-on policies;
- Enabling the signalling of an alarm if the compressor operating hours exceed the maximum operating hours threshold.

Parameter	Description	Min	Max	M.U.
CP17	Maximum hours of use for compressor	0	6500	Hours*10

The hours of use of each single compressor can be reset from the State menu.

Selecting/deselecting compressors

Each individual compressor can be selected from the State menu. Deselection of a compressor entails the following:

- The compressor availability is set to zero
- Zero setting of all its possible alarms
- Its alarms are not managed

Compressor block

Management of this alarm applies both to step compressors and to compressors with continuous regulation and is active if the compressor is selected. The activation of this alarm blocks the compressors in use. In the case of step compressors, the availability of another compressor is checked at the same time as the compressor block. If it is available it will be selected depending on the policy (CP10) and immediately switched on.

CONDENSATION CONTROL

The device can be configured to manage an inverter fan or one or more homogenous digital fans (max. 4) by setting parameter Fn25:

Parameter	Description	Min	Max	M.U	Notes
Fn25	Number of fans per step for fan coil	-1	4	Num	-1 = no condensation. 0 = continuous fan. >0 = Fn25 represents the number of digital fans.

By setting parameter **Fn25**=-1 it is also possible to define that the fan is absent (no condensation) and the relative regulator will not be actuated. If a probe is configured as a temperature probe or outlet pressure probe, the condensation regulation is proportional or Neutral Zone (NZ). In the case of pressure regulation, the AI4 probe must be used (low resolution probe). If no outlet probe has been configured, the fans will be piloted by default depending on the operating mode (Heat or Cool). In local or remote OFF the fans are switched off.

The fan can be directly connected to the controller via the Triac output or relay or indirectly connected via an external module (connected to controller via a PWM or analogue output):

- Direct Triac TC output
- Indirect "PWM" output AO1, AO2 (needs external module for piloting fan).
- Indirect 4..20mA / 0..20mA / 0..10Vcc output AO3 (needs external module for piloting fan).
- Relay outputs for piloting digital fans
- Digital Output DO5 (Open Collector) using an external relay.

One or more digital inputs can be configured as fan thermal switch:

- Digital inputs DI1...DI7.
- Analogue inputs AI3 ...AI4 if configured as digital inputs.

It is possible to configure a relay as fan INVERTER enabling output.

INVERTER COMPRESSOR CONTROL

Pick-up

Each time the fan starts, the exchanger fan is supplied at the maximum voltage level, hence the fan runs at the speed established by parameter **Fn23** (max. pick-up speed) for a time equal to the value set via parameter **Fn13** (pick-up time). After this time, the fan will continue at the speed set by the regulator. However if the regulator wants to turn the ventilation off during the pick-up time, the fan will be switched off. The pick-up time will be reloaded at the next start.

The speed specified by parameter **Fn23** may be reached in one of two ways depending on the value of parameter **Fn12** (mode for reaching maximum pick-up speed):

- 0 = the regulator immediately sets the output proportional to the speed specified by parameter **Fn23** and maintains this speed for the time specified by parameter **Fn13**.
- 1 = the regulator actuates the proportional output according to a ramp that allows the speed specified by parameter **Fn23** to be reached in the time specified by parameter **Fn13**.

If **Fn13**= 0, pick-up is disabled. The regulation may be at central set or side set depending on parameter **St01**.

The use of the interstep times **Fn16** and **Fn17** is enabled and they are loaded during the instrument switching on and switching off phases. To prevent uncertainty, it is recommended to set the values to 0.

Regulation

The operating mode depends on parameter **ST02**. Cold mode **St02** = 1. Hot mode **St02** = 0.

If no condensation probe has been allocated (temperature or pressure), the fan ON/OFF switch will be controlled on request from the compressor in cooling mode or in heating mode if **Fn10** = 1, otherwise if **Fn10** = 0 the fan is always ON.

When the fan is ON it is piloted at the speed set by parameter **Fn24**. If however a condensation probe has been allocated, the fan control is proportional as a function of the condensation probe value. The fan may be regulated independently from the compressor or at the request of the compressor depending on parameter **Fn10** (operation on request by compressor): If **Fn10**=0 then condensation is controlled independently from the compressor, however if **Fn10**=1 then the fan is OFF when all of the compressors available are OFF.

The minimum cut-off is bypassed for the time specified by parameter **Fn14** on start-up of the compressor. If the regulator requests the cut-off during this period the fan is piloted at the minimum speed set by parameter **Fn20**.

Note: The cut-off does NOT force the fans to be switched on but only prevents them from being switched off. The following diagrams illustrates the fan speed and the digital inverter enabling output as a function of the regulation probe in the case of regulation with lateral set point (**St01**=1). In the case of central set point (**St01**=0), the proportional band is deemed to be centred in the set point:

Parameters **Fn08** (enable minimum cut-off) and **Fn09** (enable saturation cut-off) activate or deactivate the cut-off function. Note that if the minimum cut-off is disabled, the speed of the fan goes from 0 to the minimum speed when the regulation probe reaches the set point from "below". If the regulation probe reaches the setpoint from "above", the speed will go from minimum speed to 0.

Similarly, if the saturation cut-off is disabled, the fan speed goes from continuous regulation to maximum silent speed when the regulation probe reaches the Set Point+Proportional Band from "below".

If the regulation probe reaches Set point+Proportional Band from "above", there will be continuous regulation between maximum silent speed and minimum speed.

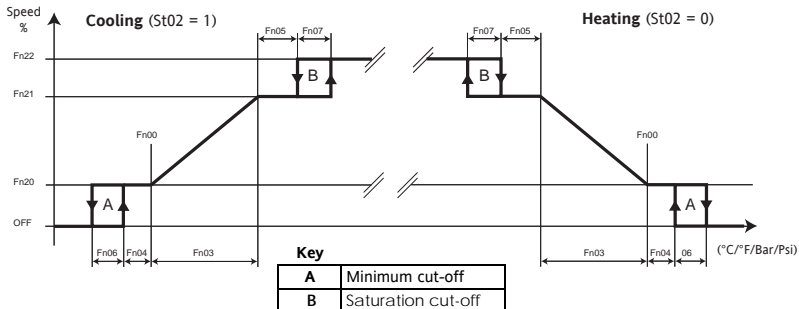

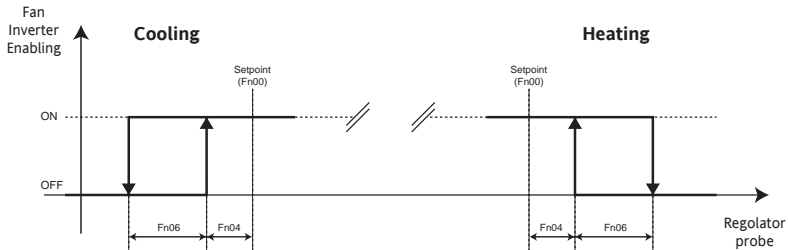

The digital inverter enabling output is activated in each case in which the analogue output has a value other than 0%. The above drawing represents only the nominal case in which the cut-off hysteresis is enabled at the minimum.

Inverter prevention (cold mode only)

If parameter **Fn10**=1 (if the compressor is OFF, the fan is OFF) and **Fn15**<>0, the prevention is also active. Before the compressor is switched on, the fan is switched on for a time equal to **Fn15**; the fan speed is proportional to the value of the regulation probe. However, if during this period the regulator requests the switching off of the fan, the fan will be piloted at the minimum speed set by parameter **Fn20**. This is to avoid the compressor switching on when the condensation probe values are excessively high. If, at the end the prevention, the regulator does not request fans, the fan is switched off immediately. The prevention is reset if the right parameter conditions are present and if the inlet request is zeroed and then returns (even if the request is cancelled by its alarm or the outlet alarm). In the event of a regulation probe error, the fan ON/OFF switch will be controlled on request from the compressor. When the fan is ON it is piloted at the speed set by parameter **Fn24**.

DIGITAL FAN CONTROL

Pick-up

On each activation request by the regulator, all of the exchanger fans are activated simultaneously for a time equal to the value set using parameter Fn13 (pick-up time).

After this time has elapsed, the fans will be piloted at the speed set by the regulator. If, during the pick-up time, the regulator wants to turn the ventilation off, the fans will be switched off. The pick-up time will be reloaded at the next start. If **Fn13**= 0 the pick-up is disabled.

Activation and deactivation of power steps must respect the activation and release times for resources **Fn16** and **Fn17**, which are loaded at activation/release.

The use of the interstep times **Fn16** and **Fn17** is enabled in the case of a continuous fan and they are loaded during the instrument switching on and switching off phases. To prevent uncertainty, it is recommended to set the values to 0.

Proportional band regulation: this occurs if bit1 of parameter **ST04** equals 0 (this occurs for St04=0 and St04=1).

The operation depends on the parameter **ST02**: Cooling mode if St02=1 and Heating mode if St02=0.

If no condensation probe has been allocated (temperature or pressure), the fan ON/OFF switch will be controlled on request from the compressor in cooling mode or in heating mode if Fn10=1, otherwise if Fn10=0 the fan is always ON. During the ON phase, the number of fans switched on in respect to the number of those present depends on the value set at parameter Fn24. If however a condensation probe has been configured, the fan control is by steps as a function of the condensation probe value.

The regulator activates a certain number of resources (power steps) to reach the Set point configured (**Fn00**). The number of resources required is linked to the difference between the value measured by the condensation probe and the set point; The greater this difference, the greater the number of resources required to reach the set point. The temperature/pressure interval between application of one power step and the next depends on the proportional band and the number of resources present.

The fan may be regulated independently from the compressor or at the request of the compressor, depending on parameter Fn10 (compressor operation on request).

If **Fn10=0** then the condensation control is independent of the compressor, if, however, **Fn10=1** then the fan is off when all of the compressors available are off.

The cut-off at minimum is bypassed for the time set at parameter **Fn14** after the compressor is activated. If the regulator requests the switching off of the fans during this time, the fans will be piloted at the minimum speed (1 step). The following is an example of regulation with lateral set point (**St01=1**). In the case of central set point (**St01=0**), the proportional band is deemed to be centred in the set point:

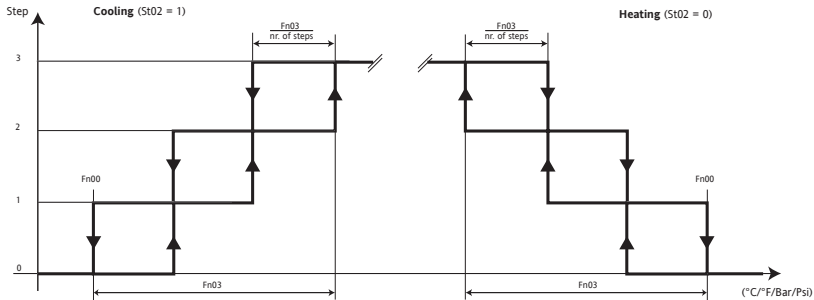

Neutral zone regulation: this occurs if bit1 of parameter **ST04** equals 1 (this occurs for **St04=2** and **St04=3**).

The operation depends on the parameter **ST02**: Cooling mode if **St02=1** and Heating mode if **St02=0**.

If a condensation probe has not been allocated (in temperature or in pressure) the fans are On OFF controlled on request by the compressor in cooling mode or in heating mode if **Fn10=1** otherwise, if **Fn10=0**, the fan is always ON.

During the ON phase, the number of fans that are switched on in comparison to the number of those present is a function of the value set for parameter Fn24.

If a condensation probe has been allocated, the fan control will be in steps with a neutral zone in function of the value of the condensation probe and the set times.

Fan regulation can be done independently of the compressor or upon request of the compressor in function of the parameter Fn10 (operation on compressor request): if Fn10=0 condensation control is independent of the compressor, if Fn10=1 instead, if all of the available compressors are off, the fan is off.

The minimum cut-off is bypassed for time set for parameter Fn14 from switching on the compressor. During this period, if the regulator requests the fans to switch off, they will be controlled at the minimum speed (one step).

The main function of the regulator with a neutral zone consists in activating/deactivating a number of resources (discrete power steps) linked to the time in which the delivery probe takes on values outside of the symmetric proportional band in comparison to the set point value.

For the cooling mode, for example, when the value read by the delivery probe exceeds the $SET\ POINT + (BANDA)/2$ threshold value, if the increasing interstep time (set with FN16) has already expired, an increase in power is implemented and the FN16 time is recounted (increasing interstep time). If the value read by the delivery probe remains in this range, an additional power increase is activated for each "increasing interstep time" (set with FN16). The operation is similar for switching off, with the times set by parameter FN17 (decreasing interstep time). Within the PROPORTIONAL BAND, no variation in power is required.

Hysteresis is not included in this algorithm.

The addition and removal of power steps must respect the activation and release times between resources **Fn16** and **Fn17** that are loaded upon their activation/release. In case of Neutral Zone regulation, the position of the Setpoint is always central, independently from the value of the parameter St01. An example is shown below:

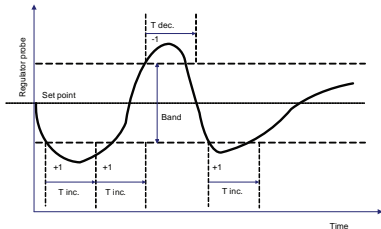
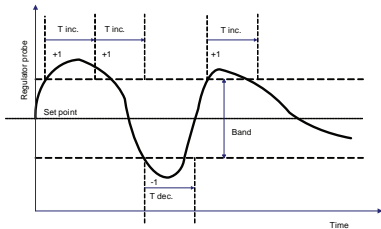

Digital fan prevention (cold mode only)

If the parameter $Fn10=1$ (if the compressor is OFF, the fan is OFF) and $Fn15 <> 0$, the prevention function is active. Prior to switching on the compressor, the fans will be activated for a time equal to $Fn15$; the number of fans activated is proportional to the value of the regulation probe but is not less than 1. This is to avoid the compressor switching on when the condensation probe values are excessively high.

If, at the end of the prevention, the regulator does not request fans, the fans are switched off immediately. The prevention is reset if the right parameter conditions are present and if the inlet request is zeroed and then returns (even if the inlet request is cancelled by its alarm or the outlet alarm). In the event of a regulation probe error, the fan ON/OFF switches will be controlled on request from the compressor. During the ON phase, the number of fans switched on in respect to the number of those present depends on the value set at parameter $Fn24$.

Digital fans rotation

In the case of step fans, rotation of the fans can be controlled during activation and release by means of parameter

Fn11. If $Fn11=0$ (fixed sequence), the activation sequence is fan 1, fan 2, ..., fan n; The sequence is inverted during deactivation, e.g. fan n..., fan 2, fan 1.

If $Fn11=1$ (operating hours), during activation the fan which worked the least is selected, while during deactivation the fan which has worked the most is selected. The aim is to balance out the operating hours between all fans.

Maximum fans stop time

Parameter **Fn18** indicates the maximum time for which the fans (continuous or digital) may remain off. Once this time has elapsed, fan pick-up is forced for the time specified by **Fn26**.

If, during the pick up time, the compressors are switched on, the minimum cut-off bypass will not be respected at the end of the pick-up time, and in the absence of a request by the fan regulator the fans will immediately be switched off.

If, during the pick up time, preventilation is activated due to the compressors being switched on, it will remain active for any remaining time after the end of the pick up time.

The function is disabled if $Fn18=0$ or if $Fn26=0$.

The time the fans are off is reinitialised each time the device is switched on.

Fan operating hours

The operating time of the fans is stored every hour in EEPROM for the purpose of:

- Managing the fan rotation function based on the operating duration.
- Enabling the signalling of an alarm if the fan operating hours exceed the maximum operating hours threshold.

Parameter **Fn19** enables the maximum number of fan operating hours to be set.

The hours of use of each individual fan can be zeroed from the State menu.

Fans thermal switch

The intervention of the digital fan thermal protection is blocked for the correctly used fan.

If another fan is available it will be selected depending on the policy (Fn11) and immediately activated. The contemporaneous intervention of the thermal protections of all of the digital fans causes an alarm which blocks the machine.

In the case of fans with continuous control or digital fans in which a single common thermal fan has been configured, the tripping of the thermal switch causes the machine to shut down.

ADVANCED FUNCTIONS

On/off device

The activation/deactivation of the device used for controlling resources may be carried out via keyboard or digital input:

- **ON/OFF from keyboard:** The device may be switched on or off using the keyboard from the Folder Programming menu **OP**. This function is not active if the ON/OFF is configured via digital input (e.g. for DI5, CF20=13). In OFF mode, the screen will display the word **OFF**.
- **ON/OFF via Digital Input:** If a digital or analogue input is configured for this function, the device state depends on the input state. In OFF mode, the word **OFF** will flash on-screen. ON/OFF via keyboard is not active.

Recording operating hours

The device records the operating hours of the compressors and fans; This data is visible in the **Hr** folder and is called CP0n (nth compressor hours), Fn0n (nth fan hours).

For values lower than 9999 the entire value is displayed, for higher values the hours/100 are displayed and the decimal point is activated. The maximum limit of recorded hours is 65535; once this value has been reached the device will automatically reset the hour counter. The display is dynamic, e.g. only the hours of actually available resources will be displayed. It is possible to set a maximum operating hours threshold, which generates an alarm as soon as it is reached (for example, for compressor or fan maintenance)

The alarm does not cause the exclusion of the regulator resource, and is displayed on-screen with a code depending on the resource that has exceeded the permitted operating hours. The alarm does not reset the operating hours. The operating hours can be reset manually from the **states** menu, **Hr** folder; When displaying the hours of a particular resource, **press and hold the “set” key to zero the operating hours of the resource (and not those of other resources).**

Real Time Clock (RTC)

The device can be supplied with a clock which makes it possible to store the time at which alarm events occurred. The parameter **CF72** is used to activate/deactivate the clock.

The current time is set using the appropriate menu as shown in the navigation menu diagram; use the Set key to confirm the value once the time and date have been modified. The value will only be saved on exiting the menu (timeout or by pressing the Esc key).

Once the time is set, the instrument must be connected for several hours to fully charge the back-up battery. The switch between legal/solar time is not automatic.

The device does not perform a real time control on the correctness of the date set; this means that it is possible to set a non-existent date such as 30/02/2007 without the machine noticing.

ALARMS

The alarms can be one of 3 types:

Automatic reset alarm: alarm active if the cause of the alarm is present, otherwise not.

Manual reset alarm: alarm active if the cause of the alarm is present, if the cause of the alarm has ceased the alarm can only be reset manually (by simultaneously pressing the UP and DOWN keys).

Semi-automatic alarm: Behaves like an automatic alarm as long as the number of events in the unit of time is less than a certain value, otherwise like a manual alarm. The unit of time can be programmed using parameter **AL00**, the number of responses can be individually programmed for each semi-automatic alarm.

Alarm events are stored with a time resolution of $T=(AL00/32)$ minutes; multiple events occurring in period T are counted as one single event.

Manual reset performed while an alarm cause is present does not enable the alarm to be reset.

It is possible to force the semi-automatic alarm to be considered only as an automatic alarm or a manual reset alarm, by setting the appropriate number of alarm responses:

- If the number of responses=0, the alarm is managed as a manual reset alarm only. At the first response, the alarm will become active and can be reset manually;
- If the number of responses=33 the alarm is managed as an automatic alarm only. At the first response, the alarm becomes active but automatically resets when the cause has ceased;

A **bypass time** is defined for semi-automatic alarms and can be set by parameter. It allows the alarm signal to be delayed, for example to enable the system to stabilise.

If the **bypass time = 0**, the alarm response is immediate (see the following diagram).

Alarm signal

See special display diagram

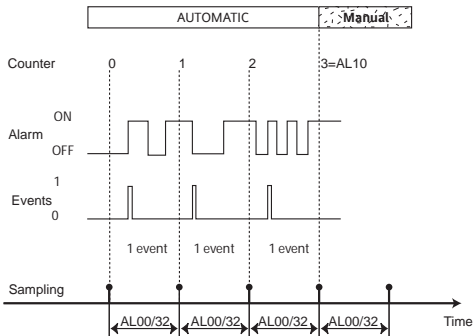

AUTOMATIC	automatic reset
Manual	manual reset
AL00/32	sampling time
Events	no. of considered events. Event 3 = (AL10)

Silence and reset alarms

Alarm silencing consists of the forced deactivation of the output configured as an alarm and is performed by pressing any key (in the presence of an alarm). Silencing has no effect on the alarm state, it only affects the signal itself; The alarm LED, which is a fixed light in the presence of an alarm, becomes a flashing light when silenced. Alarm reset consists of zeroing all pending manual reset alarms.

This is done by simultaneously pressing the UP + DOWN keys. To reset a manual reset alarm which is still active, the alarm must be first deactivated and then immediately re-entered. This causes a new entry to be stored in the alarms log and resets the alarm relay (silenced by key).

Alarms list with description and activation parameters

A= By-pass

C= n° of responses

Code	Description	Type	Cause	(Set) Activation	Hysteresis	A 1)	C 2) 3)
Er01	Low pressure switch - inlet	EVE	Inlet gas pressure switch	inlet probe<= CP00		AL02	AL01
Er02	High pressure switch - inlet			inlet probe> CP00			
Er03	Low pressure switch - outlet	EVE	Outlet pressure switch	outlet probe<= Fn00		AL04	AL03
Er04	High pressure switch - outlet			outlet probe> Fn00			
Er05	Inlet probe maximum	EVE	inlet probe>set activation	AL17 if St03=0 CP00+AL17 if St03=1	AL18	AL08	AL07
Er06	Inlet probe minimum	EVE	Inlet probe<set activation	AL19 if St03=0 CP00-AL19 if St03=1	AL20	AL06	AL05
Er07	Outlet probe maximum	EVE	Outlet probe>set activation	AL21 if St03=0 Fn00+AL21 if St03=1	AL22	AL12	AL11
Er08	Outlet probe minimum	EVE	Outlet probe<set activation	AL23 if St03=0 Fn00-AL23 if St03=1	AL24	AL10	AL09
Er09	Block compressor 1	EVE	Block compressor 1			AL14	AL13
Er10	Block compressor 2	EVE	Block compressor 2				
Er11	Block compressor 3	EVE	Block compressor 3				
Er12	Block compressor 4	EVE	Block compressor 4				
Er13	Continuous compressor shut-down	EVE	Continuous compressor shut-down				

Code	Description	Type	Cause	(Set) Activation	Hysteresis	A 1)	C 2) 3)
Er14	Fan thermal switch 1	EVE	Fan thermal switch 1			AL16	AL15
Er15	Fan thermal switch 2	EVE	Fan thermal switch 2				
Er16	Fan thermal switch 3	EVE	Fan thermal switch 3				
Er17	Fan thermal switch 4	EVE	Fan thermal switch 4				
Er18	Continuous fan thermal switch shared fans thermal switch	EVE	Continuous fan thermal switch shared fans thermal switch				
Er19	Operating hours exceeded Compr. 1	MAN	Operating hours comp1>CP17				
Er20	Operating hours exceeded Compr. 2	MAN	Operating hours Com2>CP17				
Er21	Operating hours exceeded Compr. 3	MAN	Operating hours Comp3>CP17				
Er22	Operating hours exceeded Compr. 4	MAN	Operating hours comp4>CP17				
Er23	Operating hours exceeded Compr. Inverter	MAN	Operating hours inv comp>CP17				
Er24	Operating hours exceeded Fan 1	MAN	Operating hours fan1>Fn19				
Er25	Operating hours exceeded Fan 2	MAN	Operating hours fan2>Fn19				
Er26	Operating hours exceeded Fan 3	MAN	Operating hours fan3>Fn19				
Er27	Operating hours exceeded Fan 4	MAN	Operating hours fan4>Fn19				

Code	Description	Type	Cause	(Set) Activation	Hysteresis	A 1)	C 2) 3)
Er28	Operating hours exceeded Inverter fan	MAN	Operating hours inv fan > Fn19				
Er29	General alarm	MAN	General alarm				
Er30	Inlet probe error	AUT	Operation connection defect				
Er31	Outlet probe error	AUT	Operation connection defect				
Er33	RTC communication error alarm	AUT	Clock broken				
Er34	Alarm RTC register value	AUT	Clock not regulated				
Er35	Configuration error alarm	AUT	Configuration incorrect				
Er37	Alarms log full signal	MAN	N° of log events > AL25				

- Note:
- 1) If “bypass time” = “not present”, the alarm is immediately active.
 - 2) If “N° responses in sample window” = 0, the alarm is always in manual reset
 - 3) If “N° responses in sample window” = >32 the alarm is always in automatic reset mode

Alarm list with actions and notes

Code	Action	Notes
Er01	Blocks all compressors and fans	AL02 is loaded for digital compressors whenever a power variation is applied to the system which is not due to the alarm itself; for the inverter compressor when activated. If suction probe in error, minimum alarm is always signalled.
Er02	Blocks all compressors and fans: - at maximum power (Fn22) in Cool - OFF in Heat	

Code	Action	Notes
Er03	Blocks all compressors and fans	AL04 is loaded for digital fans whenever a fan is activated/deactivated, except when the deactivation is due to the alarm itself; for the inverter fan when activated. If delivery probe error occurs, minimum alarm is always signalled.
Er04	Blocks all compressors and fans: - at maximum power (Fn22) in Cool - OFF in Heat	
Er05	Blocks all compressors and fans: - at maximum power (Fn22) in Cool - OFF in Heat	If inlet probe error occurs, management alarm disabled
Er06	Blocks all compressors and fans	If inlet probe error occurs, management alarm disabled
Er07	Blocks all compressors and fans: - at maximum power (Fn22) in Cool - OFF in Heat	If outlet probe error occurs, management alarm disabled
Er08	Blocks all compressors and fans	If outlet probe error occurs, management alarm disabled
Er09	Exclude compressor 1	AL14 is loaded on activation of the block digital input
Er10	Exclude compressor 2	
Er11	Exclude compressor 3	
Er12	Exclude compressor 4	
Er13	Exclude continuous compressor	
Er14	Exclude fan 1	AL16 is loaded on activation of the block digital input
Er15	Exclude fan 2	
Er16	Exclude fan 3	
Er17	Exclude fan 4	
Er18	Blocks the system	

Code	Action	Notes
Er19	Message	Alarm condition reset by zeroing the number, operating time and resetting the alarm. If Cp17=0 management alarm disabled.
Er20		
Er21		
Er22		
Er23		
Er24	Message	Alarm condition reset by zeroing the number, the running time and resetting the alarm. If Fn19=0, management alarm disabled.
Er25		
Er26		
Er27		
Er28		
Er29	Blocks the system	
Er30	Operation of compressor regulator from CP21.	Management of inlet analogue maximum and minimum alarms disabled. Inlet pressure switch response alarm signalled as low pressure alarm.
Er31	Operation of outlet regulator from FN24.	Management of outlet analogue maximum and minimum analogues alarms disabled. Outlet pressure switch response alarm signalled as low pressure alarm.
Er33	Message	Reset alarm by resetting the clock with current day/hour/minute and switching off/restarting.
Er34		
Er35	Blocks the system	Signalled at power-on of the device or a parameter has been modified
Er37	Message	If AL25=0, alarm disabled. Reset with log deletion

Alarms log

The alarms log enables activated alarms to be recorded with the information given below.

(If the device does not have a clock, the log can still be used but information relating to the hour and date will not be available).

Code	Description
Erxx	Alarm code
xx:zz	Event start hour/minute
dd:mm	Event start date (day: month)
xx:zz	Event end hour/minute
dd:mm	Event end date (day: month)
Auto/Man	Indication of alarm type: Automatic reset (Auto), or manual (Man)

Alarms are saved in a circular memory buffer with maximum storage limit fixed at 99; the 100th alarm will overwrite the first event registered (and so on for subsequent alarms).

The last alarm in order of time is saved as Eu00; previous alarms will move up one position (Eu00=last alarm, Eu01=penultimate alarm...).

If a clock error occurs, alarms will still be recorded but the time will not be displayed in the date and hour fields, instead the indication "- - -" will appear.

Delete alarm events

All alarms stored in the alarms log can be deleted from the Eur subfolder (Reset historical events) of the Parameter Programming menu **by keeping the "set" key pressed**; The deletion will be signalled by the Par. "YES".

The first event that occurs after the deletion will be recorded in the subfolder **EU00**.

SERIAL CONFIGURATION

All models are fitted with 1 TTL serial channel for:

- Copy card connection to upload/download parameters.
- Serial communication with personal computer via RS-232/TTL conversion modules.

The TTL serial - referred to as COM1 - can be used for:

- configuring parameters with the **ParamManager** or **DeviceManager** software using the Eliwell protocol
- configuring parameters and monitoring with Televis Net software using the Eliwell or Modbus protocol PC Interface connection modules are required.
- configuring device parameters, states, and variables with the Modbus via the Modbus protocol

For selection of the protocol and setting of the device address, see the following table:

Parameter	Description	Value
CF54	Select COM1 (TTL) protocol	0 = Eliwell 1 = Modbus
CF55	Eliwell protocol controller address	0...14
CF56	Eliwell protocol controller family	
CF63	Modbus protocol controller address	1...255
CF64	Modbus protocol Baudrate	<ul style="list-style-type: none">• 0=1200 baud • 4=19200 baud• 1=2400 baud • 5=38400 baud• 2=4800 baud • 6=58600 baud• 3=9600 baud • 7=115200 baud
CF65	Modbus protocol parity	<ul style="list-style-type: none">• 1= EVEN • 2= NONE• 3= ODD

IMPORTANT: DO NOT supply power via TTL present on PC Interface 2150 to the EWCM4120-4150-4180 device.

To avoid errors, it is **OBLIGATORY** to cut the wire corresponding to 5Vdc of the 5-pole TTL connector, as illustrated in the figure:

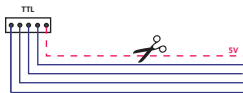

TTL CABLE 5V NOT FOR SUPPLY

Copy card

The Copy Card is an accessory which, when connected to the TTL type serial port, allows quick programming of the instrument parameters (upload and download of a parameter map to or from one or more instruments of the same type). The operations are carried out via the following commands present in the **CC** folder, consent for the operation is given by pressing the "set" key:

Fr-Format: This command is used to format the copy card, an operation which is necessary when the instrument is being used for the first time or with other models which are not mutually compatible. Important: When the copy card is formatted, all data is deleted. This operation cannot be cancelled.

UL-Upload: this command copies (uploads) the parameter values from the instrument to the copy card.

dL-Download: this command copies (downloads) the parameter values from the copy card to the instrument.

If the operation was completed successfully the word "yes" will be displayed, if not the label "Err" will appear. After the download the instrument **must be reset**.

Download from reset: Connect the copy card to the switched off instrument. When the instrument is turned on, the programming parameter values will automatically be loaded from the copy card to the instrument. After the lamp test, the display shows the following labels for about 5 seconds: "dLY" if the operation is successful, "dLn" if not. At the end of the operation, the instrument will switch to OFF status (if a digital input is set as on/off, at the end of the download from reset the instrument will assume the state of the digital input)

PARAMETERS LIST

Note: When a parameter is edited outside of the limits, the display flashes. To stop the flashing, press the UP/DOWN keys once. **NOTE: CFBP = °C/°F/Bar/Psi**

Par.	Description	Range	EWCM 4120	EWCM 4150	EWCM 4180	M.U.
	CF Folder					
CF02	Type of input analogue AI3	0...5	3	3	3	num
CF03	Type of input analogue AI4	0...5	3	3	3	num
CF04	Analogue input AI3 full scale value	Parameters CF04 ... CF11 limit table				
CF05	Analogue input AI3 start of scale value					
CF06	Analogue input AI4 full scale value					
CF07	Analogue input AI4 start of scale value					
CF10	Analogue input AI3 differential	Parameters CF04 ... CF11 limit table				
CF11	Analogue input AI4 differential					
CF14	Configuration of analogue input AI3	0...3	1	1	1	num
CF15	Configuration of analogue input AI4	0...3	0	0	2	num
CF16	Configuration of digital input DI1	-21...21	3	3	3	num
CF17	Configuration of digital input DI2	-21...21	4	4	4	num
CF18	Configuration of digital input DI3	-21...21	5	5	5	num
CF19	Configuration of digital input DI4	-21...21	6	6	6	num
CF20	Configuration of digital input DI5	-21...21	13	13	13	num
CF23	Configuration of analogue input AI1 when configured as digital input	-21...21	1	0	1	num

CF24	Configuration of analogue input AI2 when configured as digital input	-21...21	2	2	2	num
CF25	Configuration of analogue input AI3 when configured as digital input	-21...21	0	0	0	num
CF26	Configuration of analogue input AI4 when configured as digital input	-21...21	0	0	0	num
CF27	Type of output analogue AO3	0...2	-	0	0	num
CF30	Configuration of analogue output AO3	-24...26	-	0	25	num
CF33	Enable analogue TC output	0...1	1	-	-	num
CF34	Enabling analogue output AO1	0...1	1	0	0	num
CF35	Enabling analogue output AO2	0...1	-	0	0	num
CF36	Analogue TC output phase shift	0...90	27	-	-	num
CF37	Phase shift analogue output AO1	0...90	27	27	27	num
CF38	Phase shift analogue output AO2	0...90	-	27	27	num
CF39	Analogue TC output pulse length	5...40	10	-	-	num
CF40	Analogue output AO1 pulse length	5...40	10	10	10	num
CF41	Analogue output AO2 pulse length	5...40	-	10	10	num
CF42	Analogue TC output configuration	-24...26	25	-	-	num
CF43	Configuration of analogue output AO1	-24...26	25	0	0	num
CF44	Configuration of analogue output AO2	-24...26	-	0	0	num
CF45	Configuration of digital output DO1	-24...24	1	1	1	num
CF46	Configuration of digital output DO2	-24...24	2	2	2	num
CF47	Configuration of digital output DO3	-24...24	4	4	4	num
CF48	Configuration of digital output DO4	-24...24	3	3	3	num
CF49	Configuration of digital output DO5	-24...24	15	0	0	num

CF50	Configuration of digital output DO6	-24...24	-	15	15	num
CF51	Configuration of digital AO1 output	-24...24	0	0	0	num
CF52	Configuration of digital AO2 output	-24...24	-	0	0	num
CF54	Select COM1 protocol	0...1	0	0	0	num
CF55	Eliwell protocol controller address	0...14	0	0	0	num
CF56	Eliwell protocol controller family	0...14	0	0	0	num
CF63	Modbus protocol controller address	1...255	1	1	1	num
CF64	Modbus protocol Baudrate	0...7	3	3	3	num
CF65	Modbus protocol parity	1...3	1	1	1	num
CF66	Client code 1	0...255	0	0	0	num
CF67	Client code 2	0...255	0	0	0	num
CF68	Firmware version	0...999	0	0	0	num
CF71	Tab	0...999	1	5	2	num
CF72	RTC present	0...1	1	1	1	num
CF79	Firmware mask	0...999	0	0	0	num
	UI Folder					
UI00	Configuration of led1	0...32	1	1	1	num
UI01	Configuration of led2	0...32	2	2	2	num
UI02	Configuration of led3	0...32	3	3	3	num
UI03	Configuration of led4	0...32	4	4	4	num
UI04	Configuration of led5	0...32	0	0	0	num
UI05	Configuration of led6	0...32	0	0	0	num
UI06	Configuration of led7	0...32	0	0	0	num
UI07	Configuration of led8	0...32	25	0	25	num

UI08	Configuration of led9	0...32	27	0	27	num
UI09	Configuration of led10	0...32	28	0	28	num
UI10	Configuration of led11	0...32	29	0	29	num
UI12	Select main set point display	0...1	0	-	0	num
UI13	Select main display	0...6	2	2	2	num
UI20	Installer password	0...255	1	1	1	num
UI21	Manufacturer password	0...255	2	2	2	num
UI22	Unit of temperature measurement	0...1	0	0	0	num
UI23	Unit of pressure measurement	0...1	0	0	0	num
	ST Folder					
St01	Central/lateral set point	0...1	1	1	1	num
St02	Select Hot/cold operating modes	0...1	1	1	1	num
St03	Absolute/relative alarms	0...1	0	0	0	num
St04	Regulators configuration	0...3	1	1	1	num
	CP Folder					
CP00	Regulation setpoint	CP01...CP02	230	230	230	CFBP
CP01	Setpoint bottom limit	-999...CP02	-100	-100	-100	CFBP
CP02	Setpoint upper limit	CP01...9999	700	700	700	CFBP
CP03	Proportional band	0...9999	50	50	50	CFBP
CP04	Delta minimum cut-off	0...9999	20	20	20	CFBP
CP05	Delta saturation cut-off	0...9999	20	20	20	CFBP
CP06	Hysteresis minimum cut-off	0...9999	10	10	10	CFBP
CP07	Hysteresis saturation cut-off	0...9999	10	10	10	CFBP
CP08	Enable minimum cut-off	0...1	1	1	1	num

CP09	Enable saturation cut-off	0...1	1	1	1	num
CP10	Activation Policy	0...2	1	1	1	num
CP11	Enable/disable sequence of relays associated to compressor power stages in the suction section	0...2	2	2	2	num
CP12	Compressor min. OFF-ON time	0...255	1	1	1	min
CP13	Compressor min. ON-ON time	0...255	1	1	1	min
CP14	Compressor min. ON-OFF time	0...255	15	15	15	secs
CP15	Interstep up time	0...255	30	30	30	secs
CP16	Interstep down time	0...255	10	10	10	secs
CP17	Maximum hours of use for compressor	0...6500	0	0	0	Hours*10
CP18	Minimum speed	0...100	20	20	20	%
CP19	Maximum speed	0...100	80	80	80	%
CP20	Saturation speed	0...100	100	100	100	%
CP21	Default power for non-allocated probe/probe error	0...100	0	0	0	%
CP22	Number of compressor steps per circuit	0...4	4	4	4	num
CP23	Number of compressor steps 1	1...4	1	1	1	num
CP24	Number of compressor steps 2	1...3	1	1	1	num
CP25	Number of compressor steps 3	1...2	1	1	1	num
	Fn Folder					
Fn00	Regulation setpoint	Fn01...Fn02	151	-	151	CFBP
Fn01	Setpoint bottom limit	-999...Fn02	-500	-	-500	CFBP
Fn02	Setpoint upper limit	Fn01...9999	999	-	999	CFBP
Fn03	Proportional band	0...9999	20	-	20	CFBP
Fn04	Delta minimum cut-off	0...9999	20	-	20	CFBP
Fn05	Delta saturation cut-off	0...9999	20	-	20	CFBP

Fn06	Hysteresis minimum cut-off	0...9999	10	-	10	CFBP
Fn07	Hysteresis saturation cut-off	0...9999	10	-	10	CFBP
Fn08	Enabling minimum cut-off	0...1	1	-	1	num
Fn09	Enabling saturation cut-off	0...1	1	-	1	num
Fn10	Compressor operation on request	0...1	0	-	1	num
Fn11	Enable fan rotation	0...1	0	-	0	num
Fn12	Mode for reaching maximum pick-up speed	0...1	0	-	0	num
Fn13	Fan pick-up time	0...255	2	-	5	secs
Fn14	Bypass cut-off time	0...255	80	-	80	secs
Fn15	Preventilation	0...255	0	-	0	secs
Fn16	Interstep up time	0...255	15	-	15	secs
Fn17	Interstep down time	0...255	5	-	5	secs
Fn18	Maximum time all fans can stay off	0...500	500	-	500	Hours
Fn19	Maximum hours of use for fan	0...6500	0	-	0	Hours*10
Fn20	Minimum speed	0...100	40	-	40	%
Fn21	Maximum silent speed	0...100	100	-	90	%
Fn22	Maximum speed	0...100	100	-	100	%
Fn23	Maximum pick-up speed	0...100	100	-	100	%
Fn24	Default power for non-allocated probe/probe error	0...100	100	-	100	%
Fn25	Number of fans per step for fan coil	-1...4	0	-	0	num
Fn26	Fan forcing time after maximum OFF time	0...54	10	-	10	min
	AI Folder					
AL00	Time interval for alarm event count	1...99	60	60	60	min
AL01	Number of inlet pressure switch events	0...33	0	0	0	num

AL02	Inlet pressure switch alarm bypass time	0...255	0	0	0	secs
AL03	Number of outlet pressure switch events	0...33	0	0	0	num
AL04	Outlet pressure switch alarm bypass time	0...255	0	0	0	secs
AL05	Number of inlet low analogue alarm events	0...33	0	0	0	num
AL06	Inlet low analogue alarm bypass time	0...255	0	0	0	secs
AL07	Number of inlet high analogue alarm events	0...33	0	0	0	num
AL08	Inlet high analogue alarm bypass time	0...255	0	0	0	secs
AL09	Number of outlet low analogue alarm events	0...33	0	0	0	num
AL10	Outlet low analogue alarm bypass time	0...255	0	0	0	secs
AL11	Number of outlet high analogue alarm events	0...33	0	0	0	num
AL12	Outlet high analogue alarm bypass time	0...255	0	0	0	secs
AL13	Number of compressor shut-down alarm events	0...33	0	0	0	num
AL14	Compressor shut-down alarms bypass time	0...255	0	0	0	secs
AL15	Number of fan thermal switch alarm events	0...33	0	-	0	num
AL16	Fan thermal switch alarms bypass time	0...255	0	-	0	secs
AL17	Inlet probe maximum alarm switch-on threshold	-999...9999	350	350	350	CFBP ¹
AL18	Hysteresis for switching off inlet probe maximum alarm	0...9999	50	50	50	CFBP ¹
AL19	Inlet probe minimum alarm switch-on threshold	-999...9999	160	160	160	CFBP ¹
AL20	Hysteresis for switching off inlet probe minimum alarm	0...9999	50	50	50	CFBP ¹
AL21	Outlet probe maximum alarm switch-on threshold	-999...9999	195	195	195	CFBP ²
AL22	Hysteresis for switching off outlet probe maximum alarm	0...9999	20	20	20	CFBP ²
AL23	Outlet probe minimum alarm switch-on threshold	-999...9999	134	134	134	CFBP ²
AL24	Hysteresis for switching off outlet probe minimum alarm	0...9999	20	20	20	CFBP ²
AL25	Maximum number of events in alarm log for alarm signal	0...99	0	0	0	num

¹* Display in decimals if M.U. °C/°F/Psi, in centimetres if Bar.

²* Display in decimals if M.U. °C/°F/Bar, in units if Psi.

For determination of the UM and decimal point, see also parameters CP and Fn.

Parameters CF04 ..CF11 limits table

These limits depend on the measuring unit (parameters UI22 and UI23):

Par.	°C		°F		Bar				Psi			
	Min	Max	Min	Max	Min	Max	Min	Max	Min	Max	Min	Max
					Hi		Lo		Hi		Lo	
CF04	-	-	-	-	CF05	40.00	-	-	CF05	580.0	-	-
CF05	-	-	-	-	-5.00	CF04	-	-	-72.5	CF04	-	-
CF06	-	-	-	-	-	-	CF07	100.0	-	-	CF07	1450
CF07	-	-	-	-	-	-	-5.0	CF06	-	-	-72	CF06
CF08	-10.0	10.0	-18.0	18.0	-	-	-	-	-	-	-	-
CF09	-10.0	10.0	-18.0	18.0	-	-	-	-	-	-	-	-
CF10	-10.0	10.0	-18.0	18.0	-1.00	1.00	-	-	-14.5	14.5	-	-
CF11	-10.0	10.0	-18.0	18.0	-	-	-10.0	10.0	-	-	-145	145

Hi: High resolution; **Lo:** Low resolution;

WARNING The number of decimal points will therefore depend on the type of measuring unit and its resolution.

NAVIGATION MENU DIAGRAMS

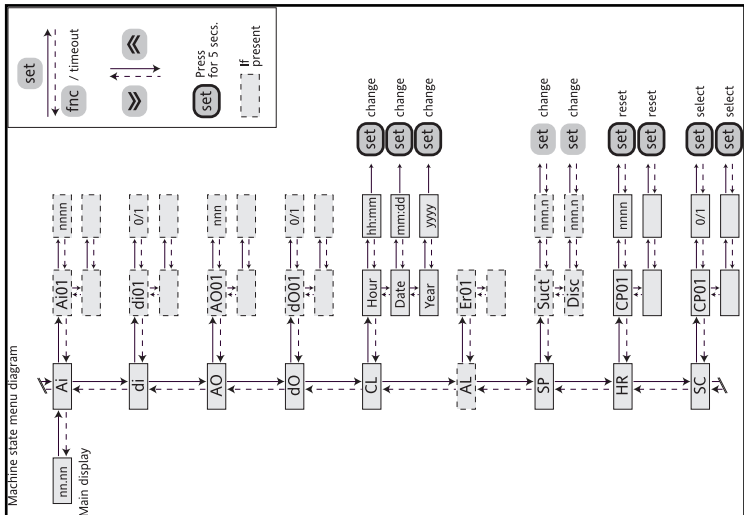

Programming menu diagram

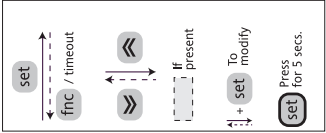
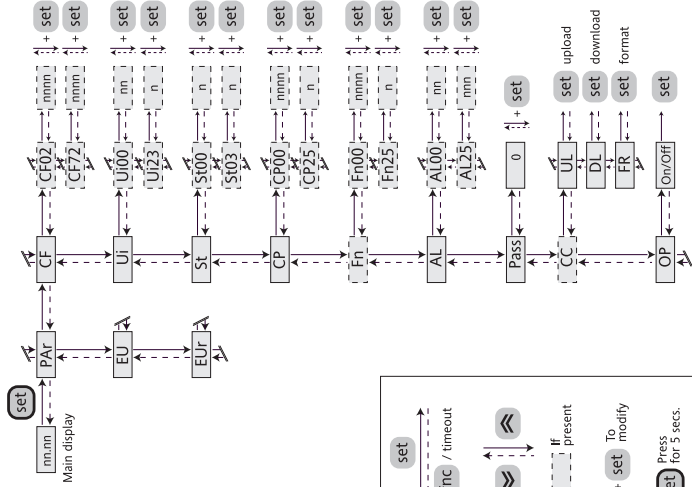

Clock setting modifications diagram

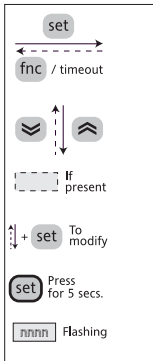
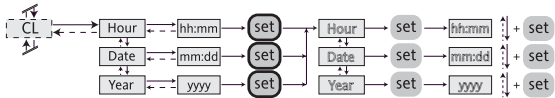
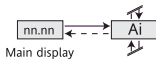

ACCESSORY PRODUCTS

The following Eliwell products may be used with the controller:

- CF10xxxxxxx devices which enable motor control (fans, pumps...) with phase cutting and using a specific input signal. Available in various models depending on the input signal (PWM or 4..20mA or 0..10V) and the pilotable load (2A or 4A or 6A or 8A)
- EXP211 device which enables control of an external resource using an open collector signal input;
- DRV module for three-phase fan piloting;
- Communication modules RS 232 TTL converter MW318934 (≤ 19200 err=0%, 38400 err=1%, ≥ 57600 err=infinite) and BusAdapter (≤ 38400 err=0%, 57600 err>0, 115200 err=infinite)
- TF411200 transformer for device power supply
- Copy card CC0500A00M000: enables the copying of parameter maps from instrument to copy card or vice-versa.
- Power cabling COHV000000100: enables the connection of the device to loads
- Signal cabling COLV000000100: enables the connection of the power supply, probes and digital inputs.
- Temperature probes SNxxxxx: NTC probes available in various lengths and cap dimensions
- Pressure probes TD2001xxx: pressure probes available in various models
- Ratiometric transducers EWPA R 0/5V with: 0/10 bar (TD400010), 0/30 bar (TD400030) or 0/50 bar (TD400050)
- **DeviceManager** 100 (DMP100x002000, where x = 1/2/3 - level)
- **ParamManager** (SLP05XX000100) with **PCInterface** 2150 (PCI5A3000000)

TECHNICAL DATA

Mechanical characteristics

Front protection	IP65
Housing	PC + ABS UL94 - V0 plastic resin casing, polycarbonate screen, thermoplastic resin keys
Dimensions	front panel 76.4x35mm (+0.2mm), depth 67mm.
Mounting	panel mounting with 71x29mm (+0,2/-0,1mm) drilling template
Temperature	operating: -10°C ... +60°C - storage: -20°C ... +85°C
Ambient humidity	operating/storage: 10...90% RH (not condensing)

Electrical characteristics

Power supply	12V~ ±10% 50/60 Hz
Consumption	5VA max
Insulation class	2 (in normal conditions, the instrument must NOT be accessible)
Display range	-999 ... +9999 (on display with 4 digit)
Connections	TTL connector for connection to Copy-card or PC (via interface)

Input/Output characteristics

	Num.	Characteristics
Analogue inputs (Configurable) [AI1..AI4]	2	Configurable as: <ul style="list-style-type: none">• NTC temperature sensor Semitec type 103AT (10kΩ / 25°C),• voltage free digital input.
	2	Configurable as: <ul style="list-style-type: none">• NTC temperature sensor Semitec type 103AT (10kΩ / 25°C),• 4..20mA current input,• 0..5V voltage input (21kΩ input impedance),• 0..10V voltage input (21kΩ input impedance),• voltage free digital input.

Digital inputs [DI1..DI5]	5	Type: voltage free with closing current for ground Closing current for ground: 0.5 mA
Digital outputs 110Vac/230Vac [DO1..DO4 e DO6]	4	EWCM4120: relay 2A resistive 250V~
	5	EWCM4150 and EWCM4180: relay 2A resistive 250V~
Triac output* [TC]	1	EWCM4120: Triac 2A max 250V~ output
Low voltage digital output [DO5]	1	Open collector, max current 35mA**
Analogue outputs (PWM/Open collector) [AO1 and AO2]	1	AO1 for model EWCM4120: Max current 35mA** (min load of 600 Ω with 12V~)
	2	AO1+AO2 for models EWCM4150 and EWCM4180: Max current 35mA** (min load of 600 Ω with 12V~)
Low voltage analogue outputs (0..10Vcc / 4..20mA) [AO3]	1	EWCM4150 and EWCM4180: For output 0...10V~, max 20mA a 10V~ (min load resistance 500 Ω). For output 4...20mA max (max load resistance) 350 Ω

*Remote control switches downstream from the Triac are NOT permitted, since they have a "holding current" (minimum current necessary to keep it turned on) above 50mA: cannot pilot loads, such as remote control switches, which have a lower current.

** Outputs AO1, AO2 and DO5 will not activate at the same time with currents greater than 20mA

eliwell

Eliwell Controls s.r.l.

Via dell'Industria, 15 • Zona Industriale Paludi • 32010 Pieve d'Alpago (BL) ITALY

Telephone +39 0437 986 111 • Facsimile +39 0437 989 066

Technical helpline +39 0437 986 300 • E-mail techsuppeliwell@invensyscontrols.com

www.eliwell.it

© Eliwell Controls s.r.l. 2009 All rights reserved.

ISO 9001



Cod. 9MA10015

Rel. 09/09

EN